

NOTE: THIS DRAWING IS PRELIMINARY. PLEASE REFER TO THE CERTIFIED BLUEPRINT FOR FINAL DIMENSIONS.

Horizontal Distance	Inside Clearance
1'	8'-6"
2'	9'-4.5"
3'	9'-10.5"
4'	10'-3"
5'	10'-5"

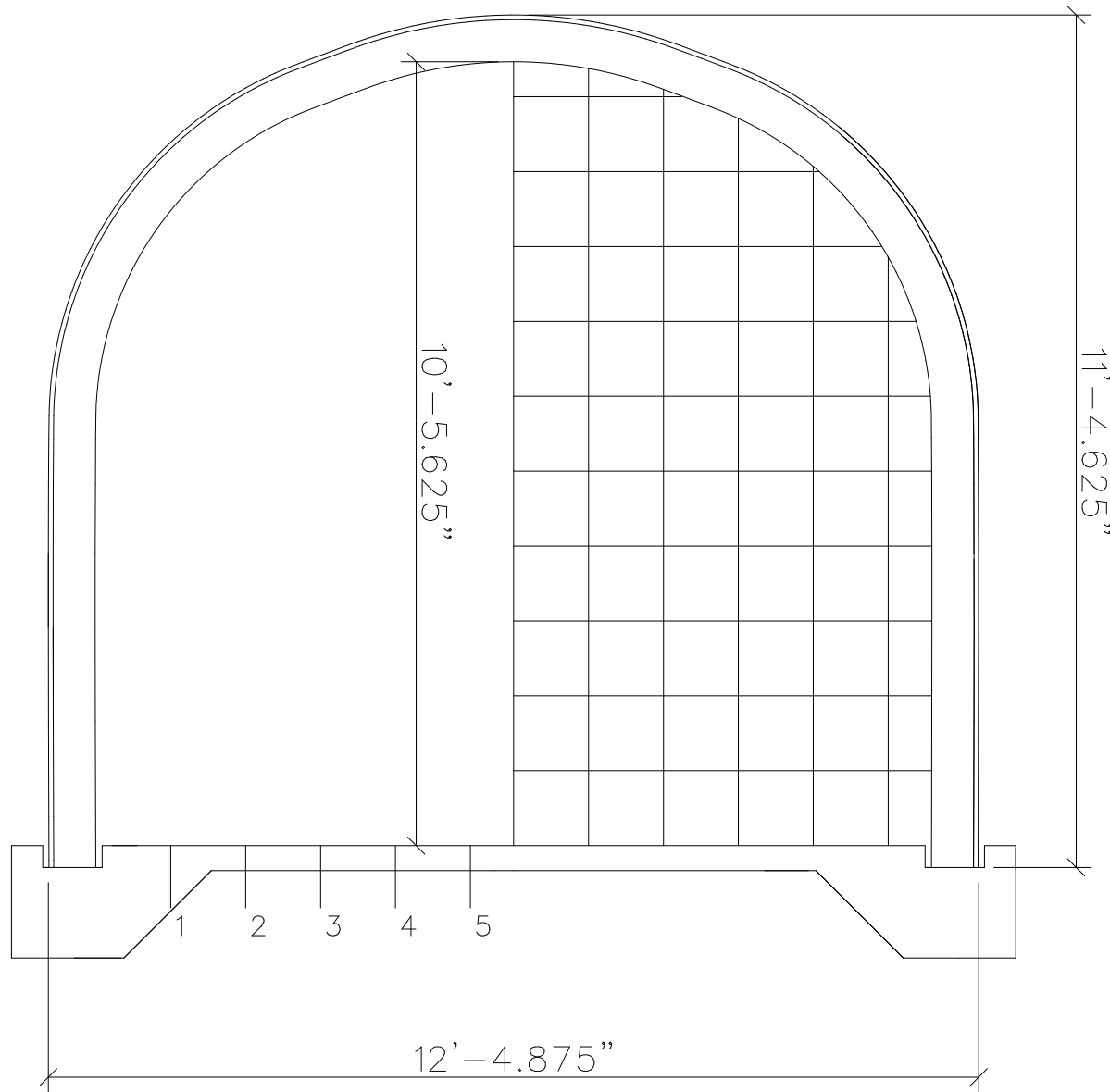

Standard 120" panels: 0	1 short panel: 71.44	bolts/arch: 102	Date: 2024-06-17
2 eave panels: 92.25	str. wall panels: 2@71.44		
Endwall area, sq.ft: 126.25	Volume/ft, cu.ft: 121.63	Surface area/arch, sq.ft: 76.10	Total arch length: 362.87

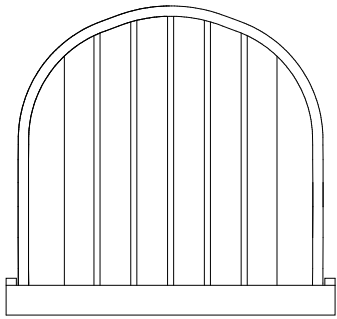

REAR ELEVATION

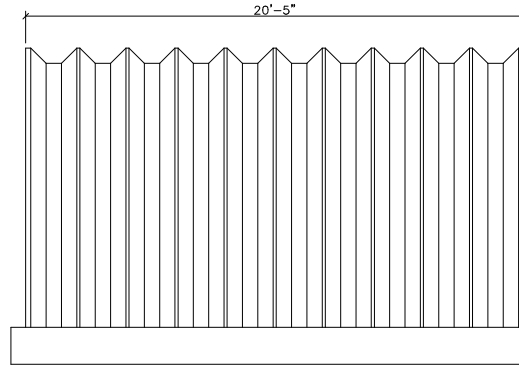

SIDE ELEVATION

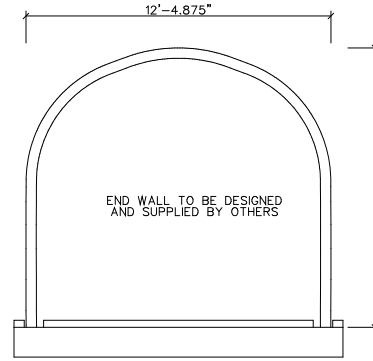

FRONT ELEVATION

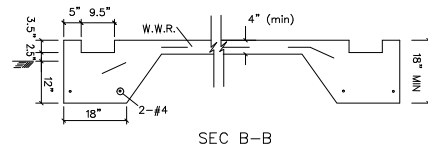
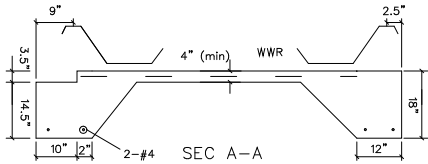

WARNING: DO NOT REMOVE OR REDUCE THE CONCRETE FLOOR OR THE REINFORCING STEEL, AND/OR RAISE THE TOPS OF THE FOOTERS ABOVE THE FLOOR OR BUILDING FAILURE MAY RESULT

- Minimum Concrete Cover:
- (a) Concrete Cast against earth: 3"
  - (b) Concrete exposed to earth or weather: No. 6 through No. 10 bars: 2"  
No. 5 bar and smaller: 1.5"
  - (c) Concrete not exposed to earth or weather: 0.75"

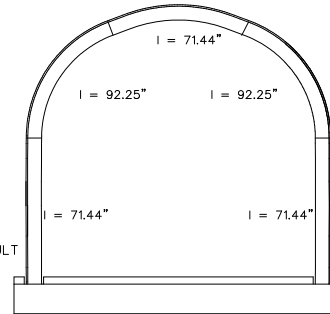

ARCH PROFILE

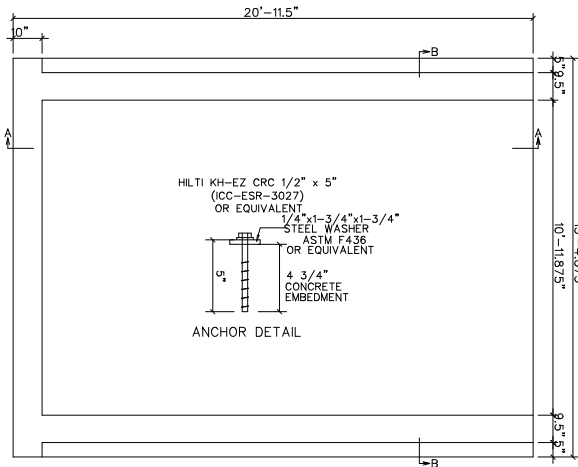

FOUNDATION PLAN

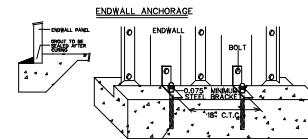
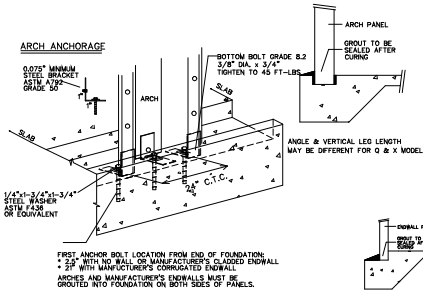

ANCHOR LOCATIONS:  
 \* SOLID ENDWALL = 2" FROM BUILDING CENTERLINE, THEN 18" C.T.C.  
 \* OPEN ENDWALL = 2" FROM DOOR FRAME OPENING, THEN 18" C.T.C.

- GENERAL NOTES
1. ALL MATERIAL AND WORKMANSHIP SHALL CONFORM WITH THE REQUIREMENTS OF THE LATEST REVISION OF THE INTERNATIONAL BUILDING CODE 2006. DESIGN ACCORDING TO NASPEC-01, NORTH AMERICAN SPECIFICATION FOR THE DESIGN OF COLD-FORMED STEEL STRUCTURAL MEMBERS, AND WITH ANSI/ASCE 7-05.
  2. NO LOADS OTHER THAN THOSE GIVEN UNDER "DESIGN DATA" BELOW SHALL BE IMPOSED ON THE "STRUCTURE".
  3. SPECIFIC NOTES AND DETAILS SHOWN ON THE DRAWINGS SHALL TAKE PRECEDENCE OVER THE BUILDING MANUAL SUPPLIED.
  4. THE BUILDING, INCLUDING THE FOUNDATION, MUST BE CONSTRUCTED IN STRICT ACCORDANCE WITH THE DRAWING AND ERECTION INSTRUCTIONS. ANY DEVIATION UNLESS APPROVED BY US IN WRITING, SHALL NULLIFY OUR CERTIFICATE AND SEAL AND SHALL BE THE SOLE RESPONSIBILITY OF THE ERECTOR.
  5. A PROFESSIONAL ENGINEER SHOULD BE RETAINED WHERE SITE INSPECTIONS ARE WARRANTED.
  6. NO ARCH PANEL MAY BE CUT OR MODIFIED UNLESS IT IS TO ACCOMMODATE AN ACCESSORY PROVIDED BY THE MANUFACTURER IN ACCORDANCE WITH ITS INSTRUCTIONS AND/OR THIS DRAWING.
  7. MINIMUM SEPARATION FROM THIS BUILDING TO ANY TALLER BUILDING MUST BE THE SMALLER OF 20 FEET AND 6 TIMES THE HEIGHT DIFFERENCE.
  8. IF SEALED BY AN ENGINEER, THIS DRAWING IS FOR PERMIT APPLICATION. OTHERWISE IT IS A DRAFT AND NOT FOR CONSTRUCTION.

- FOUNDATION NOTES
- NOTE: THE FOUNDATION ON THE DRAWING SPECIFIES THE MINIMUM REQUIREMENTS. LOCAL BUILDING CODE AND SITE CONDITIONS MAY REQUIRE A STRONGER FOUNDATION, WHICH MUST BE DESIGNED BY A LOCAL ENGINEER.
1. THE FOUNDATION SHALL BE FOUNDED ON NATURAL UNDISTURBED SOIL CAPABLE OF SAFELY SUSTAINING 1500 psf. THIS SHALL BE DESIGNED TO FULLY RESIST ALL ROTATION AT THE BASE OF THE ARCH.
  2. SLAB ON GRADE SHALL BE PLACED ON WELL COMPACTED SOIL CAPABLE OF SUSTAINING 1500 psf WITHOUT APPRECIABLE SETTLEMENT.

- DESIGN DATA (MATERIALS)
1. CONCRETE  $f'_c = 2500$  PSI @ 28 DAYS, ACI
  2. REINFORCING STEEL GRADE 40,  $F_y = 40$  KSI, ASTM A615
  3. W.W.R.  $F_y = 65$  KSI, ASTM A185.
  4. W.W.R.  $6 \times 6 = W14 \times W14$

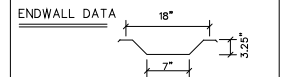
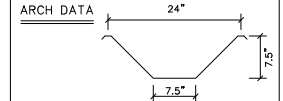

LEGAL NOTE  
 This drawing is the property of Future Steel Buildings Intl. Corp. Any duplication of this drawing in whole or in part is strictly forbidden. Anyone doing so will be prosecuted under the full extent of the law.

REVISIONS	
Future Steel Buildings Intl. Corp.	
220 Chrysler Drive, Brampton, Ontario, Canada, L6S 6B6, Phone: (905) 790-8500	
SCALE:	N.T.S.
DATE:	2024-08-07
PROJECT:	CHECKED BY:
MODEL:	S12-11