

DIAPHRAGM SCHEDULE
SHEETING IN DIAPHRAGM SECTIONS (SHOWN AS HATCHED AREA ON ELEVATIONS) NOT TO BE CUT UNDER ANY CIRCUMSTANCES

WALL	DISTANCE FROM WALL EDGE
Endwall 'A'	6'-11" O.C.
Endwall 'B'	0'-0" TO 30'-0"

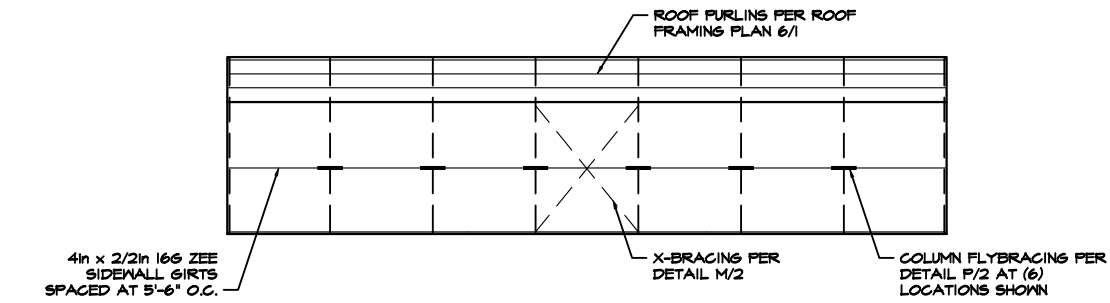

3 SIDEWALL 'B' EXTERIOR ELEVATION
1 SCALE: 1/8" = 1'-0"

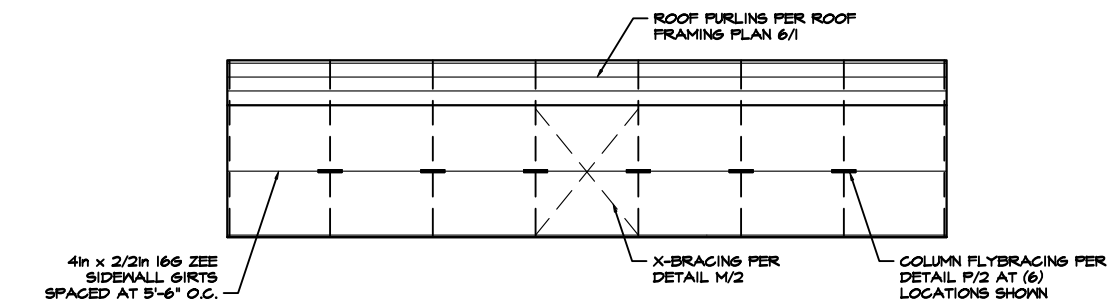

2 SIDEWALL 'A' EXTERIOR ELEVATION
1 SCALE: 1/8" = 1'-0"

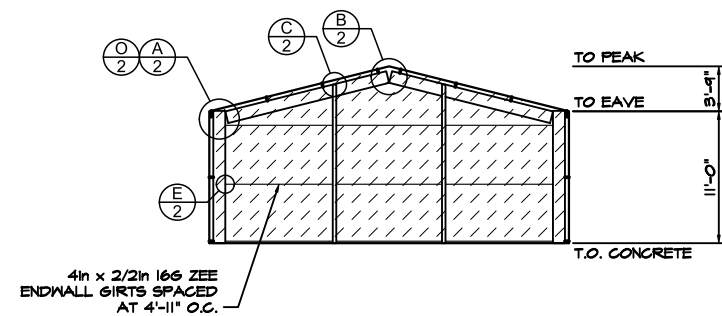

4 ENDWALL 'B' INTERIOR ELEVATION
1 SCALE: 1/8" = 1'-0" FRAME #6

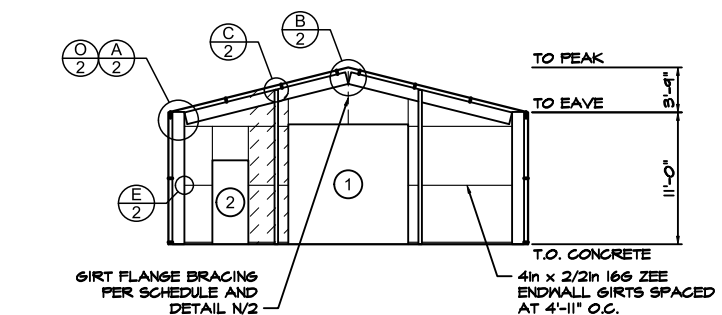

5 ENDWALL 'A' INTERIOR ELEVATION
1 SCALE: 1/8" = 1'-0" FRAME #1

ROOF DIAPHRAGM NOTE
ROOF SHEETING IS USED AS DIAPHRAGM TO BRACE THE BUILDING AND IS NOT TO BE CUT UNDER ANY CIRCUMSTANCES

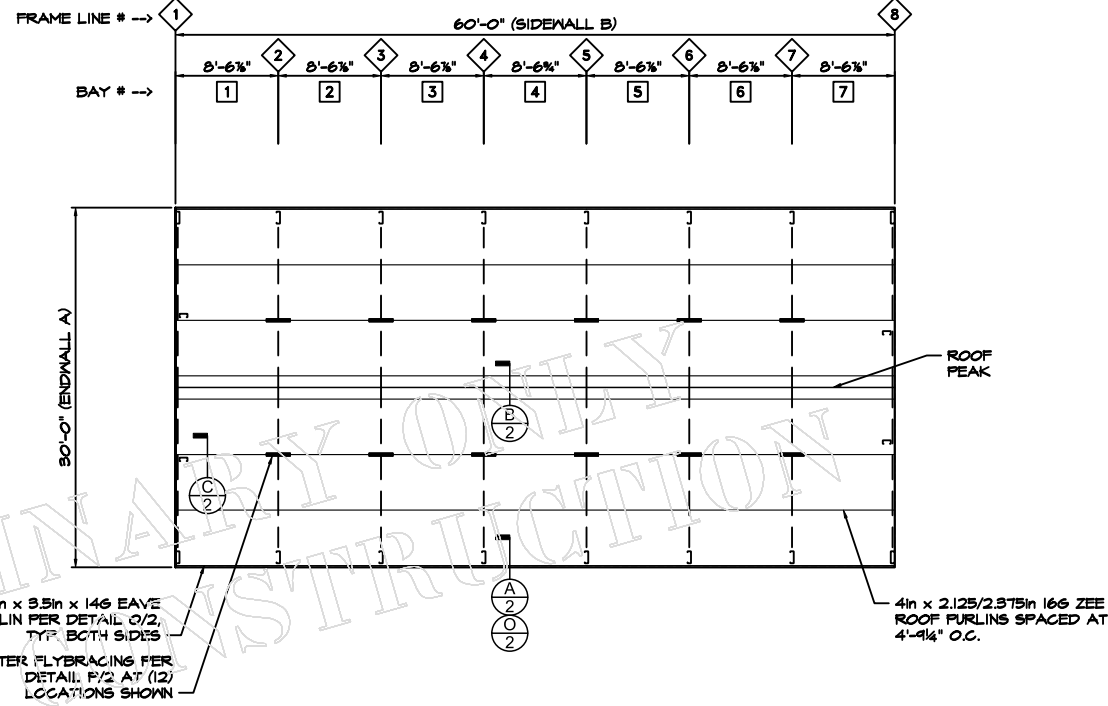

6 ROOF FRAMING PLAN
1 SCALE: 1/8" = 1'-0"

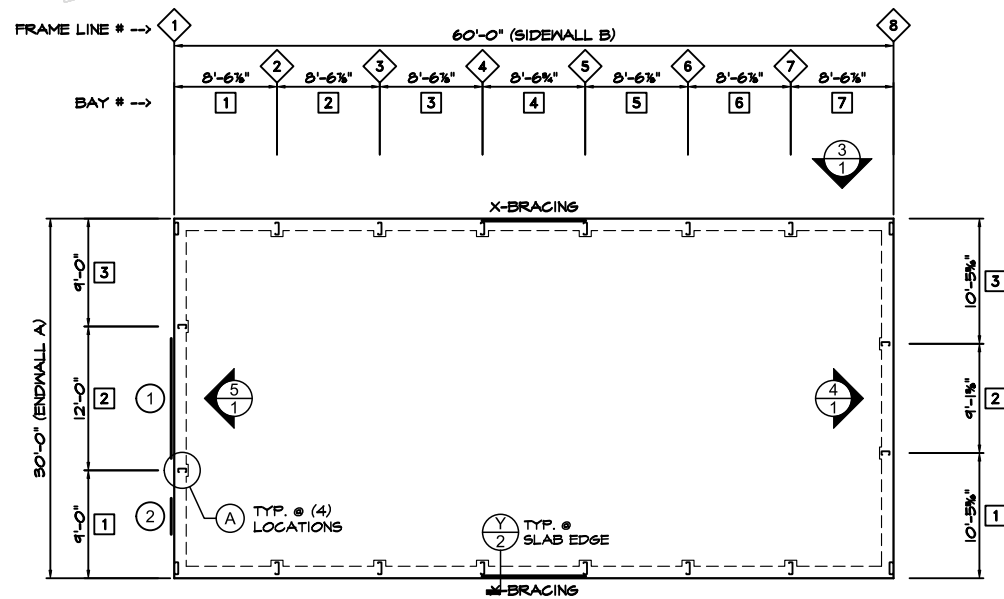

1 FOUNDATION PLAN
1 SCALE: 1/8" = 1'-0"

NOTE: USE 1/2" x 3" DEWALT 'SCREW-BOLT+' ANCHOR IN 3/2" DEEP HOLES AT ANCHOR LOCATIONS PER BASE DETAIL F/2, INSTALLED PER ICC REPORT ESR-3884, SECTION 4.3.

NOTE: SEE "TYP. FRAME CROSS-SECTION" DETAIL ON SHEET 2 FOR SPECIFIC FRAME DETAIL INFORMATION.

NOTE: EXCEPT AT DOOR OPENINGS, INSTALL L4x2x1/8 ANGLE TO FOUNDATION (FOR ATTACHMENT OF BOTTOM OF WALL SIDING) WITH 1/4in x 1 1/4in NAIL DRIVE MASONRY ANCHOR ANCHORS AT 18.0" O.C. (6" MAX. FROM ANY END).

IMPORTANT: IN ADDITION TO THESE PLANS (WHICH ALWAYS TAKE PRECEDENCE), YOU SHOULD HAVE THE FOLLOWING FROM ACT BUILDING SYSTEMS:

- CONSTRUCTION PACKAGE
- INSTALLATION MANUALS
- CONSTRUCTION VIDEOS

PLEASE CONTACT YOUR SALES REP IF YOU HAVE NOT RECEIVED THESE PRIOR TO STARTING CONSTRUCTION.

PROJECT DESIGN CRITERIA

ROOF DEAD LOAD: 3 psf
 ROOF COLLATERAL LOAD: 0 psf
 GROUND SNOW LOAD: 50 psf Ct = 1.0
 ROOF SNOW LOAD: 35 psf
 ROOF LIVE LOAD: 20 psf
 WIND SPEED: 106 mph
 WIND EXPOSURE: C
 Ss: 0.083 Sds: 0.084
 S1: 0.046 Sd1: 0.074
 SEISMIC DESIGN CATEGORY: A (for both periods)
 R transverse: 3.0 R longitudinal: 3.0
 RISK CATEGORY: II
 SOIL BEARING PRESSURE: 1500 psf

WIND DESIGN OF LATERAL FORCE-RESISTING SYSTEMS IS BASED ON THE DIRECTIONAL DESIGN PROCEDURE OF ASCE 7-16, CHAPTER 27

SEISMIC DESIGN OF LATERAL FORCE-RESISTING SYSTEMS ARE AS FOLLOWS:
 -- TRANSVERSE: ORDINARY STEEL MOMENT FRAME (SEISMIC DESIGN IS BASED ON ASCE 07-16, SECTIONS 12.1 - 12.13)
 -- LONGITUDINAL: ORDINARY STEEL BRACED FRAME (SEISMIC DESIGN IS PERFORMED USING THE SIMPLIFIED DESIGN PROCEDURE (ASCE 07-16, SECTION 12.1.4).

DESIGN BASE SHEAR: IS SHOWN ON CALCULATION SHEET M2.

COMPONENT DIAGRAM

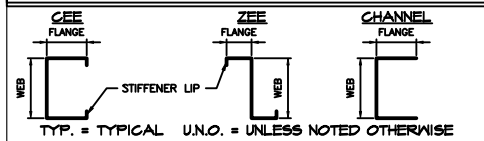

FOUNDATION DETAIL KEYS

(A) ENDWALL COLUMN (SEE DETAIL C/2 FOR TOP CONNECTION AND G/2 FOR BASE CONNECTION)

WALL OPENING SCHEDULE

DOOR	WIDTH	HEIGHT	OPENING TYPE	HEADER GIRTS	OPENING JAMBS
1	10'-0"	10'-0"	SECTIONAL DOOR	SEE NOTE #4	C4X2.5 X16
2	3'-0"	7'-0"	PERSONNEL DOOR	SINGLE	CHN4X 2X16

- NOTES:
- JAMB MEMBERS SHOWN AS "CHN" ARE CHANNEL MEMBERS (WITHOUT STIFFENER LIPS) AND THOSE SHOWN AS "C" ARE CEE MEMBERS. FIRST NUMBER IS WEB DEPTH IN INCHES, SECOND NUMBER IS FLANGE WIDTH IN INCHES, AND THIRD NUMBER IS MATERIAL THICKNESS (GAUGE).
 - SEE DETAILS J/2 AND K/2 FOR OPENING FRAMING INFORMATION.
 - SIZE OF HEADER GIRTS TO BE SAME AS SIDEWALL OR ENDWALL GIRTS, AS APPROPRIATE, PER ELEVATIONS. AT WINDOWS, INSTALL HEADER GIRTS SPECIFIED ABOVE AND BELOW WINDOWS, U.N.O.
 - AT OPENINGS NOTED, INSTEAD OF ATTACHING DOOR JAMBS TO HEADER GIRTS PER DETAIL L1/2 ATTACH DOOR JAMBS TO UNDERSIDE OF ENDWALL RAFTER PER DETAIL L2/2.
 - ALL OPENINGS AND ACCESSORIES SHALL BE CAPABLE OF SUPPORTING ALL WIND PRESSURES PERPENDICULAR TO THE SURFACE (GENERATED BY WINDS AT THE SPEED AND EXPOSURE INDICATED ABOVE) BY SPANNING BETWEEN THE JAMBS.

DEFLECTION LIMITS

FURLINS:	L/150 (STD)
GIRTS:	L/90 (STD)
EW WIND COLUMNS:	L/120 (STD)
WALL PANEL:	L/60 (STD)

PRELIMINARY
ONLY NOT FOR
CONSTRUCTION



ACTBUILDING
SYSTEMS®

DISTRIBUTOR: Toro Steel Buildings
 JOB NAME: Toro Steel Buildings
 JOB ADDRESS: 801 Broadway ave nw
 Grand Rapids, MI 49504

DRAWN
 CHECKED
 DATE: 6/18/2024
 JOB NO.: VNUJ97237062

SHEET
 1 OF 1